

Sketch 1.

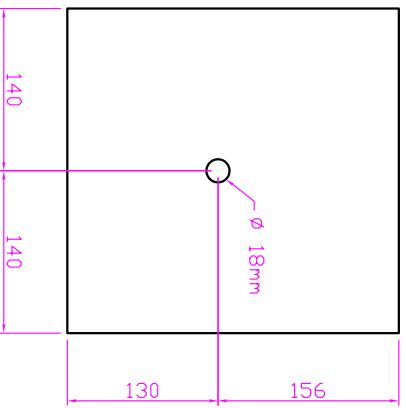

Sketch 2.

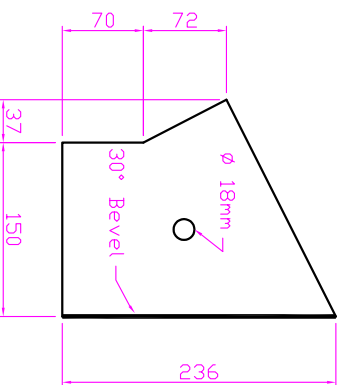

Sketch 3.

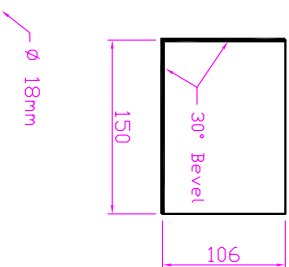

Sketch 4.

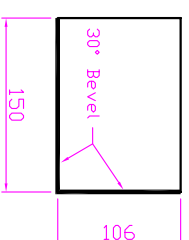

Sketch 5.

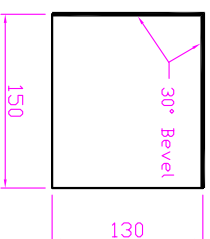

Sketch 6.

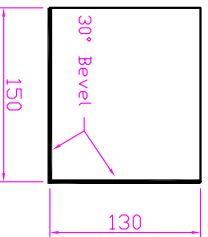

Sketch 7

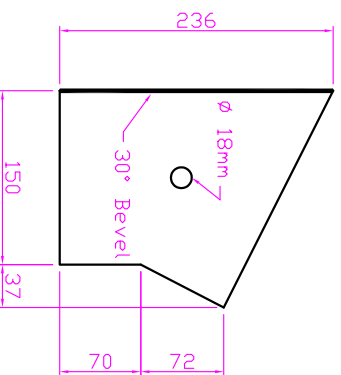

Sketch 8.

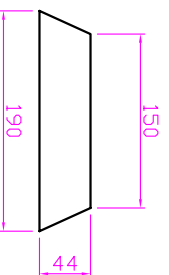

Sketch 9.

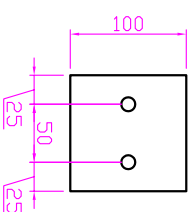

2007 U.S. Open Weld  
Trials  
Kansas City, MO  
Project #2 and 3

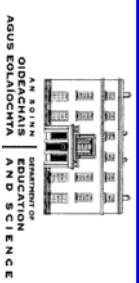

DEPARTMENT OF  
EDUCATION AND SCIENCE  
National Skills Competition  
2007  
(Final Stage)

Skill Area of Welding

Material List Sketch

ISD E  Sketch by William Irwin

Total Time Allowed Not to scale

Section B Date 26/02/2007